

TRACTION TREAD Grating

GSMTT-13R

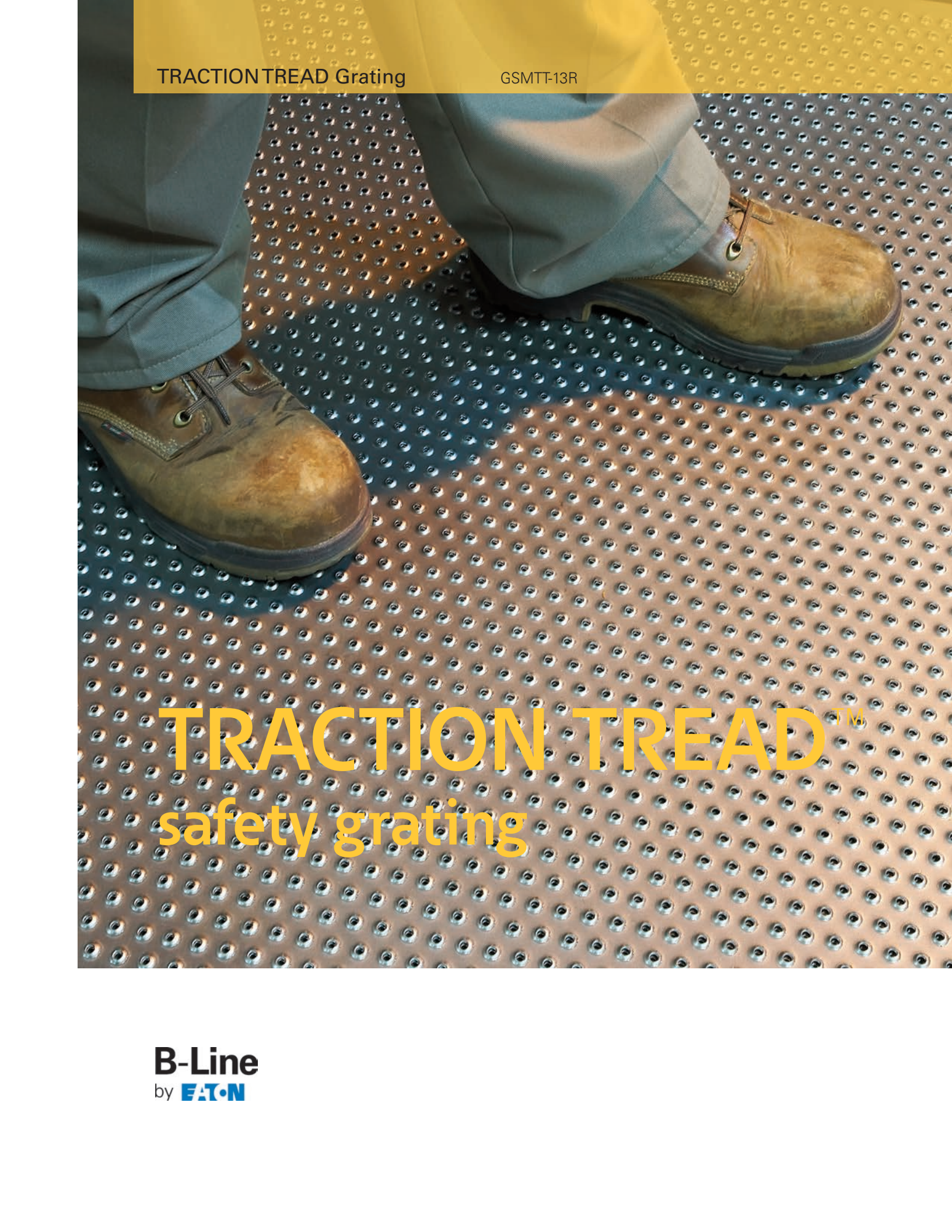

TRACTION TREAD™  
safety grating

**B-Line**  
by **FATON**

# Table of Contents & Advantages

<b>Advantages</b> .....	2
<b>Flooring Sheets &amp; Patterns</b> .....	3
<b>Design Load Tables</b> (Steel, Aluminum, Stainless Steel)	
Planks - 7" Width .....	4
Planks - 10" Width .....	5
Planks - 12" Width .....	6
Planks - 10" Width, Large Hole .....	7
<b>Stair Treads</b> .....	8
<b>Ladder Rungs</b> .....	9
<b>Accessories</b> .....	10
<b>Specifications</b> .....	11

TRACTION TREAD™ flooring feature a surface with hundreds of perforated buttons that provide slip-resistance in all directions making it a practical choice for industrial applications.

- Appropriate for commercial & industrial applications where pedestrian traffic is a consideration
- Perfectly suited for ADA-compliant requirements
- Easily adapted for a multitude of applications, offering a safe walking-working surface for walkways, ramps, stair treads and equipment platforms
- Ideal for the manufacture of special and fabricated products, and is often used as a reconditioning material over existing surfaces that do not provide slip-resistance
- Sheet Size - 36" x 120"
- Can be cut to order
- Variations of hole patterns are available upon request
- Special fabrication, cutting or specialty configurations available upon request
- Material Options: see page 3

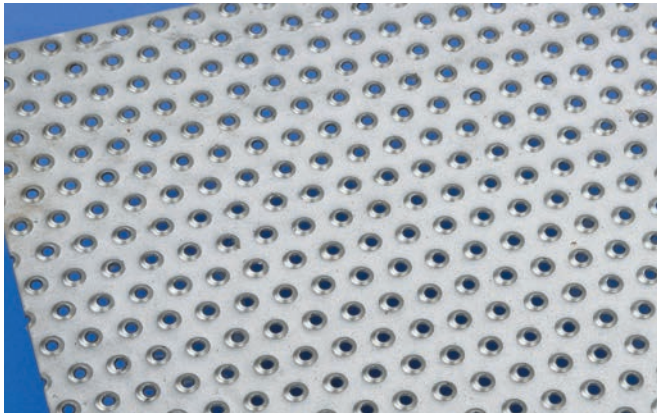

TRACTION TREAD Flooring

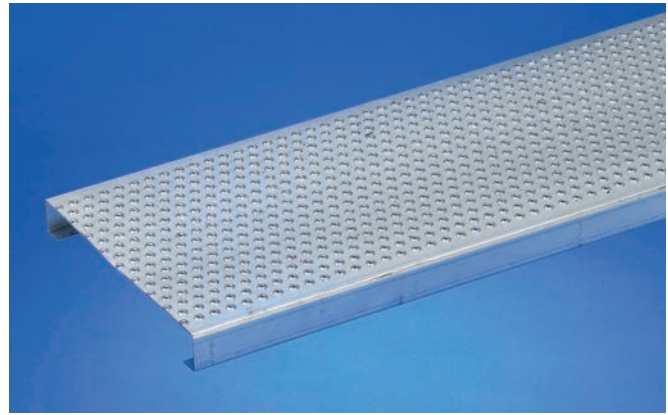

TRACTION TREAD Planks

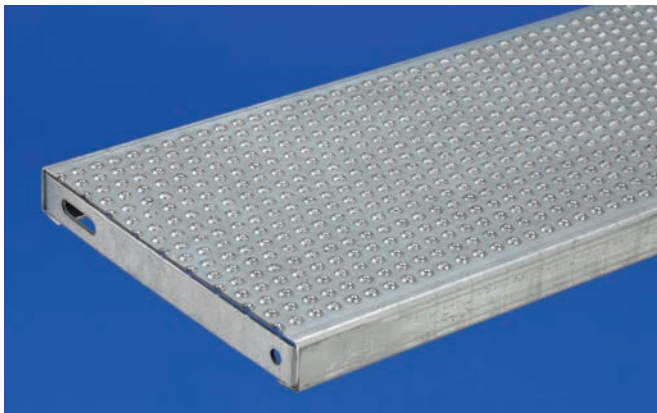

TRACTION TREAD Stair Treads



TRACTION TREAD Ladder Rungs

## TRACTION TREAD™ Flooring

Standard Pattern

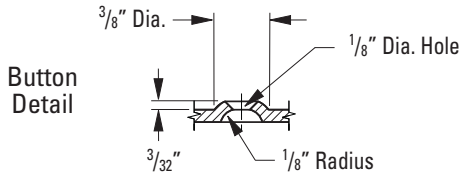
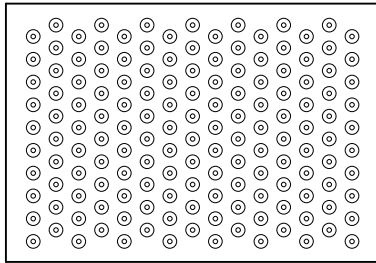

**Material Options:**

- Hot rolled, pickled and oiled carbon steel:
  - 11 gauge (5.0 lbs./sq. ft.)
  - 12 gauge (4.3 lbs./sq. ft.)
  - 13 gauge (3.8 lbs./sq. ft.)
  - 14 gauge (3.1 lbs./sq. ft.)
  - 16 gauge (2.5 lbs./sq. ft.)

- Aluminum alloy 5052-H32:
  - .125" (1.6 lbs./sq. ft.)

Note: 16 ga. 304 stainless steel is also available

**Sheet Size:**

- Standard - 36" x 120"
- Cut to order

TRACTION TREAD is available as shown above as a standard product, however, variations to the surface design can be produced according to your requirement (see examples illustrated below).

Star Pattern

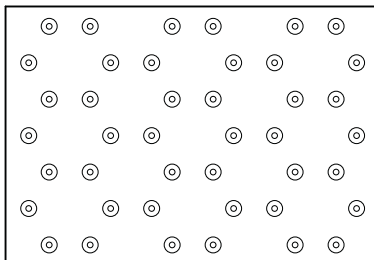

Square Pattern

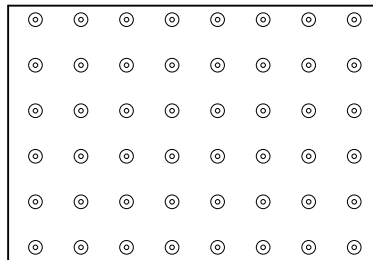

Rectangular Pattern

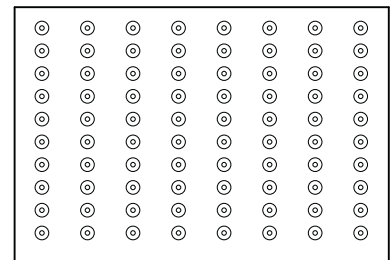

OEM Pattern

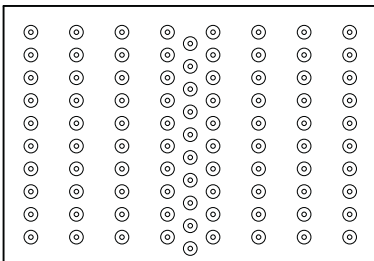

Drain Hole Pattern

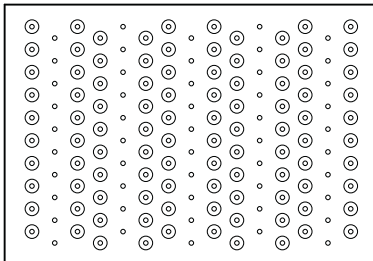

Dimple Only Pattern

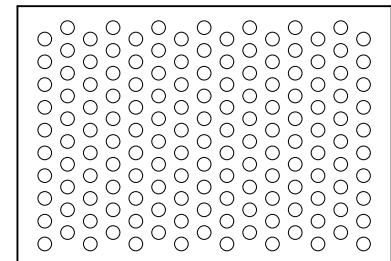

# Product

## TRACTION TREAD Plank – Width 7" Nominal (6<sup>7</sup>/<sub>8</sub>" Actual)

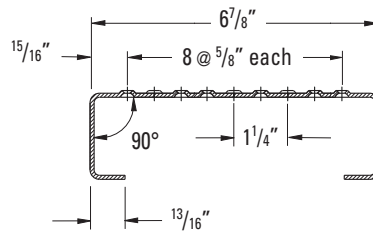
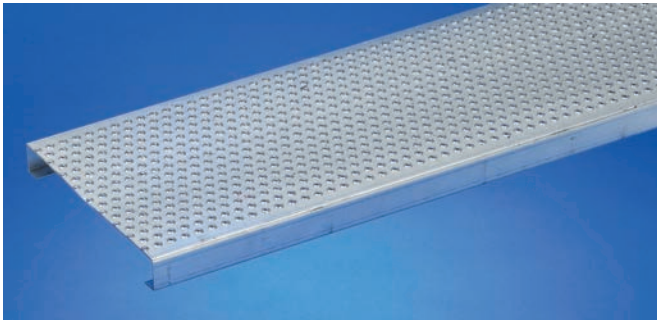

### Plank Lengths:

- 120" and 144" lengths (nominal)

### Material Options:

- Mill-galvanized steel: 11 gauge and 13 gauge
- Aluminum alloy 5052-H32: .125"
- Also available in Hot rolled, pickled and oiled carbon steel: 11 gauge and 13 gauge

### Product Selection/Design Tables

Allowable Loads and Deflections: U=Uniform Load (lb./ft.<sup>2</sup>) D=Deflection (in.)

Material Gauge	Channel Depth in. (mm)	Weight lb./lin. ft. (kg/m)	Catalog Number		Span																		
					2'-0"	2'-6"	3'-0"	3'-6"	4'-0"	4'-6"	5'-0"	5'-6"	6'-0"	6'-6"	7'-0"	7'-6"	8'-0"	9'-0"	10'-0"	11'-0"	12'-0"		
Steel 13 ga.	1 1/2" (38.1)	3.40 (5.06)	TT71513 GL	U	824	675	488	351	257	201	158	144	127	92	69								
				D	0.02	0.04	0.06	0.08	0.10	0.13	0.15	0.20	0.25	0.25	0.25	0.25	0.25						
	2" (50.8)	3.71 (5.52)	TT72013 GL	U	1642	1345	973	700	513	400	315	287	253	184	137	104	80	50					
				D	0.02	0.04	0.06	0.08	0.10	0.13	0.15	0.20	0.25	0.25	0.25	0.25	0.25	0.25	0.25				
	3" (76.2)	4.11 (6.11)	TT73013 GL	U	4378	3587	2595	1867	1368	1068	841	766	676	491	365	277	214	133	88	60	42		
				D	0.02	0.04	0.06	0.08	0.10	0.13	0.15	0.20	0.25	0.25	0.25	0.25	0.25	0.25	0.25	0.25	0.25	0.25	
Steel 11 ga.	1 1/2" (38.1)	4.72 (7.02)	TT71511 GL	U	1032	845	612	440	323	252	198	180	159	116	86								
				D	0.02	0.04	0.06	0.08	0.10	0.13	0.15	0.20	0.25	0.25	0.25	0.25							
	2" (50.8)	5.15 (7.66)	TT72011 GL	U	2084	1707	1235	889	651	508	400	364	322	233	174	132	102	64					
				D	0.02	0.04	0.06	0.08	0.10	0.13	0.15	0.20	0.25	0.25	0.25	0.25	0.25	0.25	0.25				
	3" (76.2)	6.13 (9.12)	TT73011 GL	U	5619	4603	3330	2396	1756	1370	1079	982	867	630	468	355	274	171	112	77	54		
				D	0.02	0.04	0.06	0.08	0.10	0.13	0.15	0.20	0.25	0.25	0.25	0.25	0.25	0.25	0.25	0.25	0.25	0.25	
Alum 0.125"	1 1/2" (38.1)	1.63 (2.42)	TT715125 AL	U	359	294	213	153	112	88	69	63	55	40	30								
				D	0.02	0.04	0.06	0.08	0.10	0.13	0.15	0.20	0.25	0.25	0.25								
Alum 0.125"	2" (50.8)	1.80 (2.68)	TT720125 AL	U	727	595	431	310	227	177	139	127	112	81	61	46	35	22					
				D	0.02	0.04	0.06	0.08	0.10	0.13	0.15	0.20	0.25	0.25	0.25	0.25	0.25	0.25	0.25				

### Engineering Data For Both Channels

Material Gauge	Channel Depth in.	Sx in. <sup>2</sup>	Ix in. <sup>4</sup>
Steel 13 ga.	1 1/2"	0.344	0.396
	2"	0.534	0.806
	3"	1.000	2.196
Steel 11 ga.	1 1/2"	0.273	0.316
	2"	0.420	0.636
	3"	1.711	0.782
Aluminum .125"	1 1/2"	0.348	0.400
	2"	0.540	0.815

## TRACTION TREAD Plank – Width 10" Nominal (9<sup>7</sup>/<sub>8</sub>" Actual)

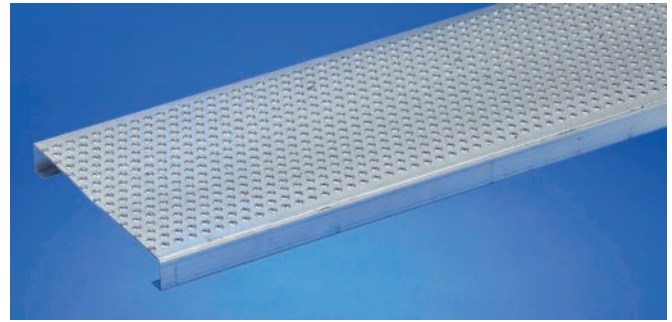
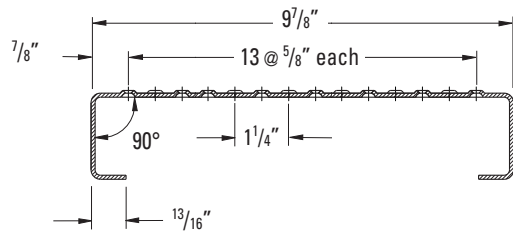

### Material Options:

- Mill-galvanized steel: 11 gauge and 13 gauge
- Aluminum alloy 5052-H32: .125"
- Also available in Hot rolled, pickled and oiled carbon steel: 11 gauge and 13 gauge

### Plank Lengths:

- 120" and 144" lengths (nominal)

### Product Selection/Design Tables

Allowable Loads and Deflections: U=Uniform Load (lb./ft.<sup>2</sup>) D=Deflection (in.)

Material Gauge	Channel Depth in. (mm)	Weight lb./in. ft. (kg/m)	Catalog Number		Span																		
					2'-0"	2'-6"	3'-0"	3'-6"	4'-0"	4'-6"	5'-0"	5'-6"	6'-0"	6'-6"	7'-0"	7'-6"	8'-0"	9'-0"	10'-0"	11'-0"	12'-0"		
Steel 13 ga.	1 1/2" (38.1)	4.32 (6.43)	TT101513 GL	U	628	515	372	268	196	153	121	110	97	70	52								
				D	0.02	0.04	0.06	0.08	0.10	0.13	0.15	0.20	0.25	0.25	0.25								
	2" (50.8)	4.63 (6.89)	TT102013 GL	U	1267	1038	751	540	396	309	243	221	195	142	106	80	62						
				D	0.02	0.04	0.06	0.08	0.10	0.13	0.15	0.20	0.25	0.25	0.25	0.25	0.25						
	3" (76.2)	5.24 (7.80)	TT103013 GL	U	3412	2795	2022	1455	1066	832	655	597	527	382	284	216	167	104	68	47	33		
				D	0.02	0.04	0.06	0.08	0.10	0.13	0.15	0.20	0.25	0.25	0.25	0.25	0.25	0.25	0.25	0.25	0.25	0.25	
Steel 11 ga.	1 1/2" (38.1)	6.01 (8.94)	TT101511 GL	U	787	645	466	336	246	192	151	138	121	88	66								
				D	0.02	0.04	0.06	0.08	0.10	0.13	0.15	0.20	0.25	0.25	0.25								
	2" (50.8)	6.44 (9.58)	TT102011 GL	U	1605	1315	951	685	502	392	308	281	248	180	134	101	78						
				D	0.02	0.04	0.06	0.08	0.10	0.13	0.15	0.20	0.25	0.25	0.25	0.25	0.25						
	3" (76.2)	7.45 (11.06)	TT103011 GL	U	4380	3588	2595	1868	1369	1068	841	766	676	491	365	277	214	134	88	60	42		
				D	0.02	0.04	0.06	0.08	0.10	0.13	0.15	0.20	0.25	0.25	0.25	0.25	0.25	0.25	0.25	0.25	0.25	0.25	
Alum 0.125"	1 1/2" (38.1)	2.07 (3.08)	TT1015125 AL	U	275	225	163	117	86	67	53	48	42	31	23								
				D	0.02	0.04	0.06	0.08	0.10	0.13	0.15	0.20	0.25	0.25	0.25								
	2" (50.8)	2.22 (3.30)	TT1020125 AL	U	560	469	332	239	175	137	107	98	86	63	47	35	27						
				D	0.02	0.04	0.06	0.08	0.10	0.13	0.15	0.20	0.25	0.25	0.25	0.25	0.25						

### Engineering Data For Both Channels

Material Gauge	Channel Depth in.	Sx in. <sup>2</sup>	Ix in. <sup>4</sup>
Steel 13 ga.	1 1/2"	0.344	0.396
	2"	0.534	0.806
	3"	1.000	2.196
Steel 11 ga.	1 1/2"	0.273	0.316
	2"	0.420	0.636
	3"	1.711	0.782
Aluminum .125"	1 1/2"	0.348	0.400
	2"	0.540	0.815

# Product

## TRACTION TREAD Plank – Width 12" Nominal (11<sup>7</sup>/<sub>8</sub>" Actual)

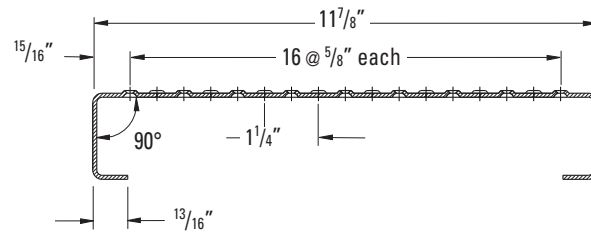
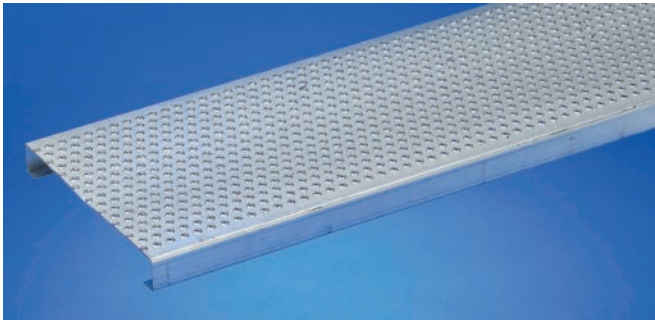

### Plank Lengths:

- 120" and 144" lengths (nominal)

### Material Options:

- Mill-galvanized steel: 11 gauge and 13 gauge
- Aluminum alloy 5052-H32: .125"
- Also available in Hot rolled, pickled and oiled carbon steel: 11 gauge and 13 gauge

### Product Selection/Design Tables

Allowable Loads and Deflections: U=Uniform Load (lb./ft.<sup>2</sup>) D=Deflection (in.)

Material Gauge	Channel Depth in. (mm)	Weight lb./lin. ft. (kg/m)	Catalog Number		Span																	
					2'-0"	2'-6"	3'-0"	3'-6"	4'-0"	4'-6"	5'-0"	5'-6"	6'-0"	6'-6"	7'-0"	7'-6"	8'-0"	9'-0"	10'-0"	11'-0"	12'-0"	
Steel 13 ga.	1 1/2"	4.93 (7.33)	TT121513 GL	U	544	445	322	232	170	133	104	95	84	61	45							
				D	0.02	0.04	0.06	0.08	0.10	0.13	0.15	0.20	0.25	0.25	0.25							
	2"	5.24 (7.80)	TT122013 GL	U	1101	902	652	469	344	268	211	192	170	123	92	70	54					
				D	0.02	0.04	0.06	0.08	0.10	0.13	0.15	0.20	0.25	0.25	0.25	0.25	0.25	0.25				
	3"	5.57 (8.29)	TT123013 GL	U	2986	2446	1769	1273	933	728	573	522	461	335	249	189	146	91	60	41	29	
				D	0.02	0.04	0.06	0.08	0.10	0.13	0.15	0.20	0.25	0.25	0.25	0.25	0.25	0.25	0.25	0.25	0.25	0.25
Steel 11 ga.	1 1/2"	6.90 (10.27)	TT121511 GL	U	682	559	404	291	213	166	131	119	105	76	57							
				D	0.02	0.04	0.06	0.08	0.10	0.13	0.15	0.20	0.25	0.25	0.25							
	2"	7.30 (10.86)	TT122011 GL	U	1395	1143	827	595	436	340	268	244	215	156	116	88	68					
				D	0.02	0.04	0.06	0.08	0.10	0.13	0.15	0.20	0.25	0.25	0.25	0.25	0.25					
	3"	8.23 (12.25)	TT123011 GL	U	3831	3138	2270	1634	1197	934	736	670	591	429	319	242	187	117	77	52	37	
				D	0.02	0.04	0.06	0.08	0.10	0.13	0.15	0.20	0.25	0.25	0.25	0.25	0.25	0.25	0.25	0.25	0.25	0.25
Alum 0.125"	1 1/2"	2.37 (3.52)	TT1215125 AL	U	238	195	141	101	74	58	46	42	37	27	20							
				D	0.02	0.04	0.06	0.08	0.10	0.13	0.15	0.20	0.25	0.25	0.25							
	2"	2.52 (3.75)	TT12220125 AL	U	487	399	288	207	152	119	93	85	75	55	41	31	24					
				D	0.02	0.04	0.06	0.08	0.10	0.13	0.15	0.20	0.25	0.25	0.25	0.25	0.25					

### Engineering Data For Both Channels

Material Gauge	Channel Depth in.	S <sub>x</sub> in. <sup>2</sup>	I <sub>x</sub> in. <sup>4</sup>
Steel 13 ga.	1 1/2"	0.344	0.396
	2"	0.534	0.806
	3"	1.000	2.196
Steel 11 ga.	1 1/2"	0.273	0.316
	2"	0.420	0.636
	3"	1.711	0.782
Aluminum .125"	1 1/2"	0.348	0.400
	2"	0.540	0.815

# TRACTION TREAD Plank (Large Hole) – Width 10"

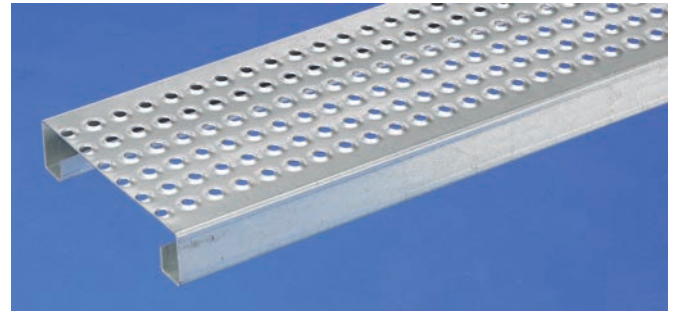
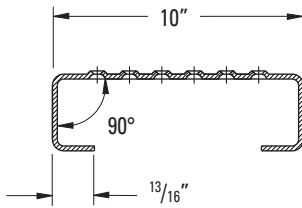

**Material Options:**

- Mill-galvanized steel: 11 gauge and 13 gauge
- Aluminum alloy 5052-H32: .125"
- Also available in Hot rolled, pickled and oiled carbon steel: 11 gauge and 13 gauge
- LH (large hole) pattern

**Plank Dimensions:**

- 120" and 144" lengths (nominal)
- 1 1/2" minimum or 2" channel height
- 3/8" hole diameter
- Not available in sheets

**Product Selection/Design Tables**

Allowable Loads and Deflections: U=Uniform Load (lb./ft.<sup>2</sup>) D=Deflection (in.)

Material Gauge	Channel Depth in. (mm)	Weight lb./in. ft. (kg/m)	Catalog Number	Span															
				2'-0"	2'-6"	3'-0"	3'-6"	4'-0"	4'-6"	5'-0"	5'-6"	6'-0"	6'-6"	7'-0"	7'-6"	8'-0"	9'-0"	10'-0"	
Steel 13 ga.	1 1/2" (38.1)	4.28 (6.37)	TT101513LH GL	U	621	508	368	265	194	151	119	109	96	70	52				
	D	0.02	0.04	0.06	0.08	0.10	0.13	0.15	0.20	0.25	0.25	0.25							
Steel 11 ga.	2" (50.8)	4.60 (6.84)	TT102013LH GL	U	1251	1025	741	533	391	305	240	219	193	140	104	79	61		
	D	0.02	0.04	0.06	0.08	0.10	0.13	0.15	0.20	0.25	0.25	0.25	0.25	0.25	0.25	0.25			
Steel 11 ga.	1 1/2" (38.1)	5.95 (8.85)	TT101511LH GL	U	777	637	461	331	243	190	149	136	120	87	65				
	D	0.02	0.04	0.06	0.08	0.10	0.13	0.15	0.20	0.25	0.25	0.25	0.25	0.25					
Alum 0.125"	2" (50.8)	6.37 (9.48)	TT102011LH GL	U	1585	1299	939	676	495	387	304	277	245	178	132	100	77		
	D	0.02	0.04	0.06	0.08	0.10	0.13	0.15	0.20	0.25	0.25	0.25	0.25	0.25	0.25	0.25	0.25	0.25	
Alum 0.125"	1 1/2" (38.1)	2.05 (3.05)	TT1015125LH AL	U	271	222	161	116	85	66	52	47	42	30	23				
	D	0.02	0.04	0.06	0.08	0.10	0.13	0.15	0.20	0.25	0.25	0.25	0.25	0.25					
Alum 0.125"	2" (50.8)	2.20 (3.27)	TT1020125LH AL	U	553	453	328	236	173	135	106	97	85	62	46	35	27		
	D	0.02	0.04	0.06	0.08	0.10	0.13	0.15	0.20	0.25	0.25	0.25	0.25	0.25	0.25	0.25	0.25	0.25	

**Engineering Data** For Both Channels

Material Gauge	Channel Depth in.	Sx in. <sup>2</sup>	Ix in. <sup>4</sup>
Steel	1 1/2"	0.344	0.396
13 ga.	2"	0.534	0.806
Steel	1 1/2"	0.273	0.316
11 ga.	2"	0.420	0.636
Aluminum	1 1/2"	0.348	0.400
.125"	2"	0.540	0.815

# Product

## TRACTION TREAD™ Stair Treads

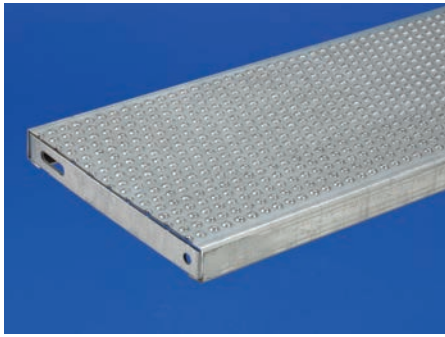

All treads have welded ends for attachment to stringers.

- Mill-galvanized steel: 11 gauge and 13 gauge
- Aluminum alloy 5052-H32: .125"
- Also available in Hot rolled, pickled and oiled carbon steel: 11 gauge and 13 gauge
- 24" to 48" lengths  
(Custom lengths can be made with the use of carrier plates)
- 7" 10" and 12" (nominal) widths
- 1½" and 2" channel heights

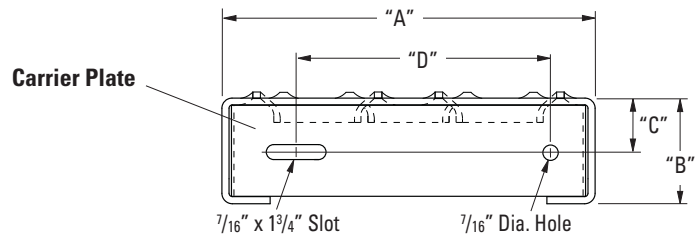

### Product Selection/Design Tables

C = Safe Allowable Concentrated Load of Center Span on Simple Beam (lbs.)  
D=Deflection (in.)

Material Gauge	Channel Depth in. (mm)	Weight lb./lin. ft. (kg/m)	Catalog Number	C	Span					
					2'-0"	2'-6"	3'-0"	3'-6"	4'-0" <sup>(1)</sup>	
<b>7" Width</b>										
Steel	1½" (38.1)	3.73 (5.55)	T-TT71513 GL	C	555	483	420	352	295	
13 ga.	2" (50.8)	4.06 (6.04)	T-TT72013 GL	C	1107	963	836	702	588	
Steel	1½" (38.1)	4.87 (7.25)	T-TT71511 GL	C	696	605	526	441	370	
11 ga.	2" (50.8)	5.43 (8/08)	T-TT72011 GL	C	1405	1222	1061	891	746	
Alum	1½" (38.1)	1.70 (2.53)	T-TT715125 AL	C	242	211	183	154	129	
.125	2" (50.8)	1.87 (2.78)	T-TT720125 AL	C	490	426	370	311	260	
<b>10" Width</b>										
Steel	1½" (38.1)	4.61 (7.16)	T-TT101513 GL	C	608	530	460	386	323	
13 ga.	2" (50.8)	4.89 (7.28)	T-TT102013 GL	C	1226	1067	927	778	651	
Steel	1½" (38.1)	6.24 (9.28)	T-TT101511 GL	C	762	663	576	483	405	
11 ga.	2" (50.8)	6.70 (9.97)	T-TT102011 GL	C	1554	1353	1174	986	826	
Alum	1½" (38.1)	2.11 (3.14)	T-TT1015125 AL	C	266	232	201	169	141	
.125	2" (50.8)	2.35 (3.50)	T-TT1020125 AL	C	542	472	409	344	288	
<b>12" Width</b>										
Steel	1½" (38.1)	5.00 (7.44)	T-TT121513 GL	C	633	551	478	402	336	
13 ga.	2" (50.8)	5.70 (8.48)	T-TT122013 GL	C	1281	1115	968	813	681	
Steel	1½" (38.1)	7.16 (10.65)	T-TT121511 GL	C	794	691	600	504	422	
11 ga.	2" (50.8)	7.58 (11.28)	T-TT122011 GL	C	1624	1414	1227	1031	863	
Alum	1½" (38.1)	2.45 (3.64)	T-TT1215125 AL	C	277	241	209	176	147	
.125	2" (50.8)	2.60 (3.87)	T-TT1220125 AL	C	566	493	428	359	301	
Deflection (same for all widths and depths)					D	0.02	0.04	0.06	0.08	0.10

### Carrier Plates

Carrier plates allow you to create your own custom stair treads. They are sold by the pair.

(2 plates = one pair).

Product Width	"A"	"B"	"C"	"D"
7" (178mm)	6 <sup>15</sup> / <sub>16</sub> " (176mm)	1½" (38mm)	¾" (19mm)	4" (102mm)
	6 <sup>15</sup> / <sub>16</sub> " (176mm)	2" (51mm)	1" (25mm)	4" (102mm)
10" (254mm)	9 <sup>15</sup> / <sub>16</sub> " (252mm)	1½" (38mm)	¾" (19mm)	7" (178mm)
	9 <sup>15</sup> / <sub>16</sub> " (252mm)	2" (51mm)	1" (25mm)	7" (178mm)
12" (305mm)	11 <sup>15</sup> / <sub>16</sub> " (303mm)	1½" (38mm)	¾" (19mm)	9" (227mm)
	11 <sup>15</sup> / <sub>16</sub> " (303mm)	2" (51mm)	1" (25mm)	9" (227mm)

Safe allowable design loads shown are concentrated at center of span on simple beam.

<sup>(1)</sup> For stair treads, intermediate stringer is recommended for spans over 4 feet.



## TRACTION TREAD™ Ladder Rungs

TRACTION TREAD ladder rungs feature a hand-overhand friendly surface with moderate slip resistance. Products are sold in efficient lengths, well suited to fabricators of ladders. Vehicle applications are an option.

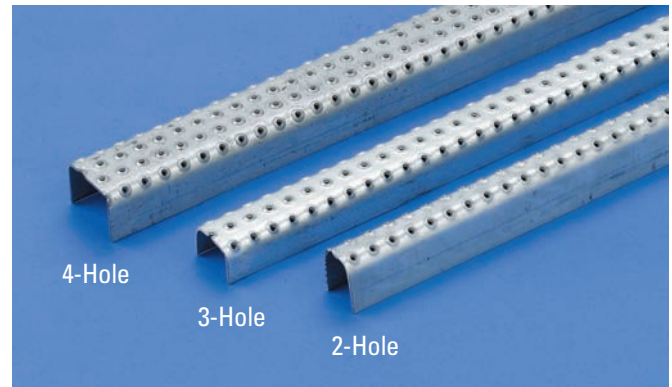

**2-Hole  
Ladder Rung**

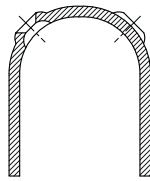

- Hot rolled, pickled and oiled carbon steel: 13 gauge (1.2 lbs./ft.)
- Aluminum alloy 5052-H32: .125" (0.5 lbs./ft.)
- 1<sup>1</sup>/<sub>4</sub>" wide x 1<sup>1</sup>/<sub>2</sub>" high x 48" or 60" long

**3-Hole  
Ladder Rung**

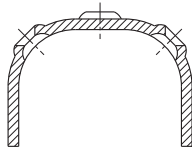

- Hot rolled, pickled and oiled carbon steel: 13 gauge (1.3 lbs./ft.)
- Aluminum alloy 5052-H32: .125" (0.5 lbs./ft.)
- 1<sup>5</sup>/<sub>8</sub>" wide x 1<sup>1</sup>/<sub>8</sub>" high x 48" or 60" long

**4-Hole  
Ladder Rung**

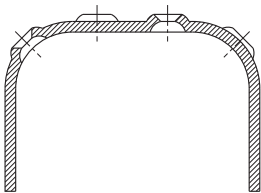

- Hot rolled, pickled and oiled carbon steel: 13 gauge (1.5 lbs./ft.)
- Aluminum alloy 5052-H32: .125" (0.7 lbs./ft.)
- 2<sup>1</sup>/<sub>4</sub>" wide x 1<sup>1</sup>/<sub>2</sub>" high x 48" or 60" long

### 2 Row Ladder Rungs

Material	Safe Allowable Concentrated Load (Lbs.)		Weight Lbs./Ln. Ft.
	48 <sup>3</sup> / <sub>4</sub> " Span	60" Span	
11 Gauge Steel	515	383	1.52
13 Gauge Steel	328	252	1.18
.125" Aluminum	207	187	0.56
16 Gauge Stainless Steel	218	183	0.82

### 3 Row Ladder Rungs

Material	Safe Allowable Concentrated Load (Lbs.)		Weight Lbs./Ln. Ft.
	48 <sup>3</sup> / <sub>4</sub> " Span	60" Span	
11 Gauge Steel	297	229	1.46
13 Gauge Steel	187	151	1.06
.125" Aluminum	163	135	0.50
16 Gauge Stainless Steel	151	103	0.73

### 4 Row Ladder Rungs

Material	Safe Allowable Concentrated Load (Lbs.)		Weight Lbs./Ln. Ft.
	48 <sup>3</sup> / <sub>4</sub> " Span	60" Span	
11 Gauge Steel	523	408	2.08
13 Gauge Steel	372	274	1.49
.125" Aluminum	280	248	0.70
16 Gauge Stainless Steel	236	201	1.03

Safe allowable design loads shown are concentrated at center of span on simple beam

The minimum safety factor = 2.0

Specifications shown are for standard products. Consult us for other options.

# Accessories

## Carriage Bolt, Flat Washer, & Hex Nut



Field drilling is required.

### Order Separately

- (1)  $\frac{3}{8}$ " -16 Carriage Bolt \*\*
- (1)  $\frac{3}{8}$ " Flat Washer
- (1)  $\frac{3}{8}$ " -16 Hex Nut

\*\* Plank carriage bolt lengths =  
Side Channel Height + 1"

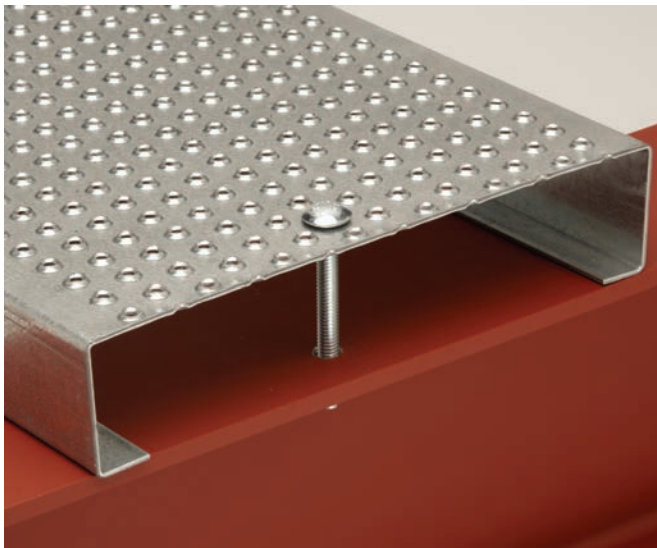
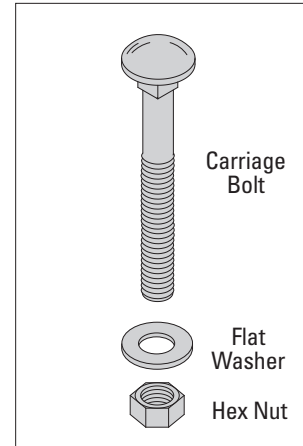

### Assembly

1. Align TRACTION TREAD planks on I-Beam or other anchoring cross-member.
2. Mark the I-Beam for drilling purposes under the third or fourth hole from the end of the TRACTION TREAD plank. Drill a pilot hole.
3. Remove TRACTION TREAD plank and drill a finish hole.
4. Drill out the hole in TRACTION TREAD plank.
5. Replace TRACTION TREAD plank to its original position. Run bolt through TRACTION TREAD plank and I-Beam. Tighten with washer and nut until secure.
6. Test for movement or slippage. If TRACTION TREAD planks are not secure, check fastening system for loose or missing parts. Repeat steps 1 thru 5.

**Note: Do not walk on TRACTION-TREAD planks if they are not secure. Serious injury could result.**

### Welding

A common method of fastening safety grating is welding. It is recommended that all B-Line Safety Grating products be fillet welded.

For more information, consult Technical Services.

## Notes to architect

1. TRACTION TREAD™ is intended for general purpose use in plants and process facilities by industry, commerce, and public facilities, for both mobile and stationary equipment.
2. TRACTION TREAD stair treads are intended for utility stairs and fire escapes in commercial, public and private buildings where local code permits.
3. These specifications are presented as a general guide to the architect or structural engineer in preparing project specifications. Allowable loads, spans and other limiting conditions presented in this catalog offer product data for use in design and construction.
4. All supports should provide a smooth, level, 1<sup>1</sup>/<sub>2</sub>" minimum bearing surface, free of burrs, bridging, welds or other irregularities.
5. Random cut ends and diagonal or circular cut exposed edges should be banded with a bar at least 1/8" thick and equal to the overall side channel depth of grating welded at contact points at the discretion of the design engineer.
6. Bolted connections, except stair or ladder tread attachment to stringer channels, may be replaced by welded connections that develop the same strength.

## Part 1: General

### 1.1 Scope

The contractor shall furnish and install TRACTION TREAD as specified and shown on the drawings.

### 1.2 Qualifications

TRACTION TREAD sheets, planks, ladder rungs, stair treads and accessories, unless otherwise indicated, shall be manufactured by B-Line, and shall be installed in accordance with its current printed directions. Safety surface shall be slip-resistant in all directions.

### 1.3 Submittals

The contractor shall furnish shop drawings of grating layout, framing and supports, unit dimensions and sections, type and location of fasteners and welds.

### 1.4 Storage and Handling

All materials shall be stored and handled to avoid damage. Damaged materials shall be removed from the premises.

## Part 2: Products

### 2.1 Flooring Materials

- a. Type: TRACTION TREAD Flooring
- b. Metal and Finish: (carbon steel — hot rolled, pickled and oiled, ASTM A1011) (aluminum, alloy 5052-H32)
- c. Metal gauge: (14-ga. HRPO steel) (13-ga. HRPO steel) (12-ga. HRPO steel) (11-ga. HRPO steel) (16-ga. HRPO steel) (14-ga. stainless steel) (.125" aluminum)
- d. Sheet Size: (36" x 120")

### 2.2 Plank Grating

- a. Type: TRACTION TREAD Plank
- b. Metal Gauge and Type: (11 and 13 gauge carbon steel — hot rolled, pickled and oiled, ASTM A1011) (11 and 13 gauge mill-galvanized steel — ASTM A924), (.125" aluminum, alloy 5052-H32)

### 2.3 Ladder Rungs

- a. Type: TRACTION TREAD Ladder Rungs
- b. Metal Gauge and Type: (13 gauge mill-galvanized steel, ASTM A924) (13 gauge carbon steel — hot rolled, pickled and oiled, ASTM A1011) (.125" aluminum, alloy 5052-H32) (14 gauge stainless steel, alloy Types 304-2B/D)
- c. Width: (1<sup>1</sup>/<sub>4</sub>" ) (1<sup>5</sup>/<sub>8</sub>" ) (2<sup>1</sup>/<sub>4</sub>" )
- d. Length: (48" ) (60" )

## Part 3: Execution

### 3.1 Condition of surfaces

Prior to TRACTION TREAD installation, contractor shall inspect supports for correct size, layout and alignment and verify that surfaces to receive grating are free of debris. The contractor shall report to the design or consulting engineer or owner's agent in writing any defects considered detrimental to proper application of traction tread so defects can be remedied before grating is applied.

### 3.2 TRACTION TREAD installation

Install TRACTION TREAD in accordance with manufacturer's recommendations and shop drawings. Sheet goods by their nature are intended to cover surface only. They require adequate support and hold down. Position traction tread planks flat and square with ends bearing min. 1<sup>1</sup>/<sub>2</sub>" on supporting structure. Keep traction tread sections at least 1/4" away from vertical steel sections and 1/2" from concrete walls. Installation clearances are built into this product. Allow clearance at joints between sections of max. 1/4" at side channels and max. 3/8" at ends. When specified, band random cut ends and diagonal or circular cut exposed edges with a min. 1/8" thick bar welded at contact points.

### 3.3 Stair Tread Installation

Install TRACTION TREAD stair treads as shown on the drawings. Fasten treads to stair stringers with 3/8" x 1" machine bolts and nuts.

- a. For stair treads, intermediate stringer is recommended for spans over 4 feet.

B-Line's U.S. Customer Service Center is staffed Monday through Friday from 7 a.m. to 5:00 p.m. Central Standard Time.  
For more information visit, [www.cooperblineline.com/grating](http://www.cooperblineline.com/grating)

**Eaton's B-Line Business**  
United States  
509 West Monroe Street  
Highland, IL 62249  
United States  
Phone: (800) 582-3643  
[www.cooperblineline.com/contactus](http://www.cooperblineline.com/contactus)

**Eaton**  
1000 Eaton Boulevard  
Cleveland, OH 44122  
United States  
[Eaton.com](http://Eaton.com)

**Eaton's B-Line Business**  
509 West Monroe Street  
Highland, IL 62249  
Phone: 800-851-7415  
Fax: 618-654-1917  
[www.cooperblineline.com](http://www.cooperblineline.com)

© 2014 Eaton  
All Rights Reserved  
Printed in USA  
Publication No. GSMTT-13R  
August 2014

Eaton is a registered trademark  
All other trademarks are property  
of their respective owners.